

Ultifresh™ Reusable Mask

FEATURED ON

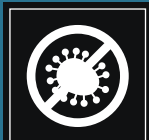

Breathable



Anti-Bacterial



Washable



Cost Saving

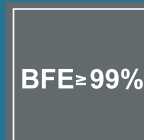

BFE ≥99%



Eco-Friendly



High Color Fastness



Dust Free Production



Safe To Wear

PRODUCT SUMMARY



	FIT	✓	FITS FACE CONTOUR DESIGN
	HYDROPHOBIC/ WATER REPELLANT	✓	YES
	FABRIC TYPE	✓	KNITTED FABRIC THAT GOES WITH FACE CONTOUR
	BREATHABLE & COMFORT	✓	HIGH
	EASY TO WASH	✓	DRIES IN 6 - 10 HOURS
	COLOR FASTNESS	✓	ABLE TO WITHSTAND 40 - 60 DEGREE WATER
	ADJUSTABLE LOOPS	✓	YES
	BACTERIAL FILTRATION	✓	99.9% HIGH BFE PROTECTION
	SAFE TO WEAR	✓	CERTIFIED BY SGS & INTERTEK
	ANTI - BACTERIAL	✓	99.94% SUSTAINABLE AFTER 50 WASHES
	NATURAL FABRIC TOUCHING OUR SKIN	✓	100% NATURAL MADE COTTON
	DUST FREE ENCLOSED PRODUCTION	✓	YES
	CUSTOMIZE OPTION	✓	ABLE TO ADD LOGO / CHANGE STRING / CUSTOM PACKING

- Drying speed based on air dry in room temperature
- Number of usage based on normal washing
- Outer mask fabric is hydrophobic & water repellant based on World Health Organization(WHO) mask guidelines

FACE MASK MARKER

Kids Face mask

Adult Face mask

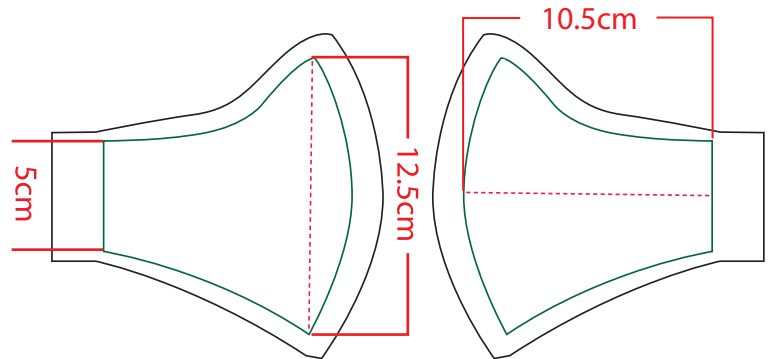
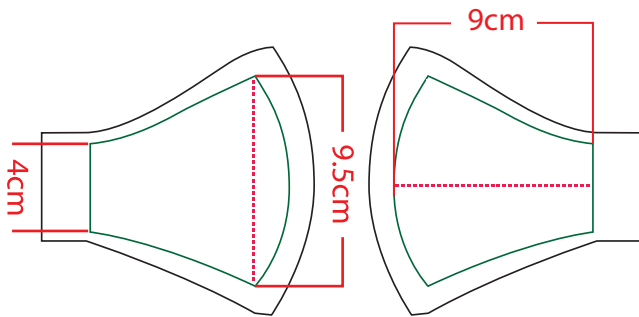

▪ Left

▪ Right

▪ Left

▪ Right

FACE MASK GUIDELINES

Adult Face mask

Cut Piece Outline

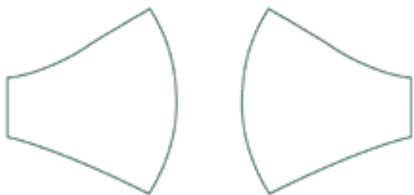

*Where the design template will be trimmed out and sew.
*Please fill in the whole layout.

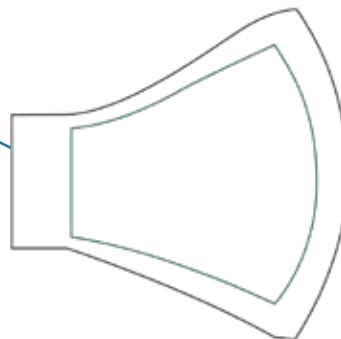

▪ Right

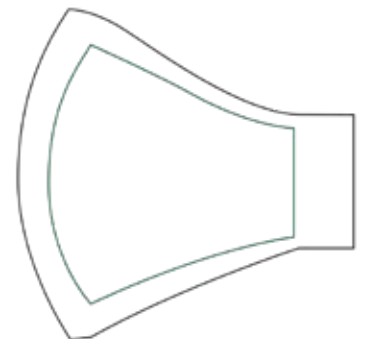

▪ Left

Kids Face mask

Safe Zone



*Please place important things within the green line.
eg: Logos, wordings

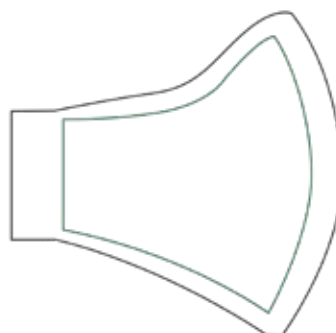

▪ Right

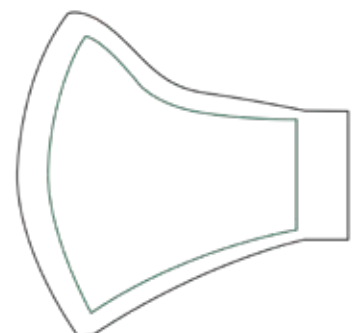

▪ Left



Adjustable Ear Loop

Suitable for all sizes



Inner Layer 100% Softstyle Cotton

Extreme Comfort



Bacterial Filtration

99.9% high BFE protection



ACTUAL PRODUCT



3X SUPERIOR
LAYERS PROTECTION

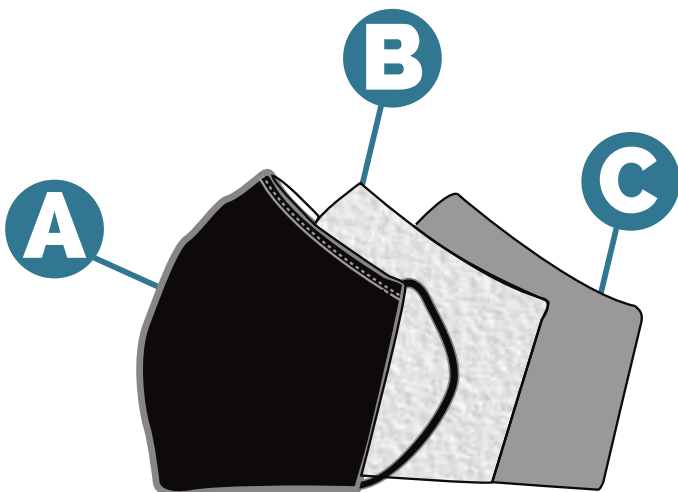

A Anti Bacteria Fabric with
Ultifresh™ Treatment

B BFE ≥ 99%
Virus Filtration Sheet

C 100% Softstyle
Cotton

MASK FILTRATION EFFICIENCY



A OUTERMOST LAYER

Ultifresh technology fabric. capable of eliminating 99.94% bacteria.

B CENTER LAYER

BFE 99% melt-blown fabric to filter out contaminants.

C INNERMOST LAYER

100% soft style cotton. Giving all users maximum comfort.

ULTIFRESH™ REUSABLE MASKS FILTER 99 PERCENT OF PARTICLES WITH A MASS MEDIAN DIAMETER OF 0.3 μm.

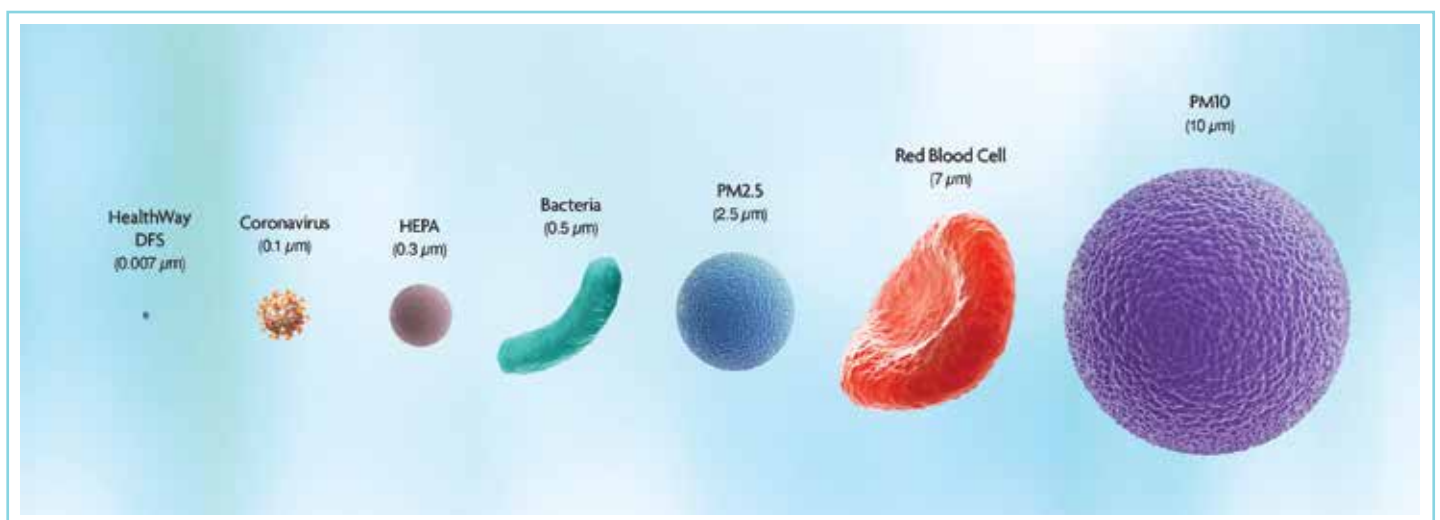

WASHABLE & REUSABLE



Do not dry clean



Hand washable



Do not bleach



Do not tumble dry



Do not iron



Leave to dry

HOW TO USE

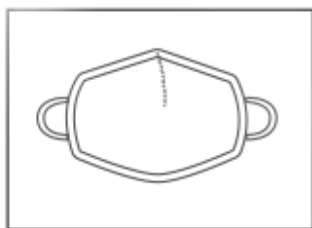

1

SPREAD OPEN
THE MASK

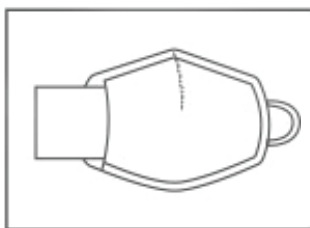

2

INSERT THE
FILTRATION SHEET
FROM THE SIDE



3

TUCK THE EARLOOPS
OVER YOUR EARS

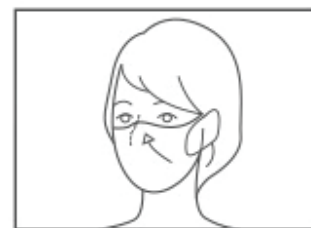

4

ADJUST THE MASK
TO FIT YOUR
FACE COMFORTABLY

COMPARING

ULTIFRESH™ REUSABLE MASK TO WHO RECOMENDED FACE MASK

ULTIFRESH™ REUSABLE MASK

OUTERMOST LAYER

Function:

Limits external contamination/ droplets from penetrating through to the wearer's nose and mouth.

Material:

Anti bacteria fabric with Ultifresh treatment hydrophobic (repels water)

CENTER LAYER

Function:

Prevents germs from entering our nose and mouth.

Material:

Virus filtration sheets

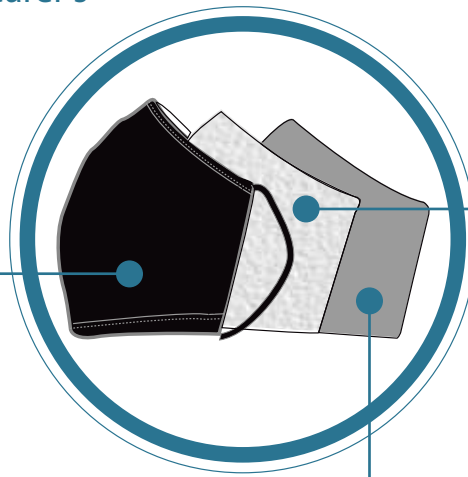

INNERMOST LAYER

Function:

Absorb the heat and liquid droplets from our body, leaving our skin dry and comfortable.

Material:

100% softstyle cotton, hydrophilic (absorbs water)

DESIGNED AND MANUFACTURED ACCORDING TO WORLD HEALTH ORGANIZATION (WHO) RECOMMENDED FABRICS

INNER LAYER

Material properties: Hydrophilic (absorbs water)

Material examples: Cotton or mixed cotton

Function: Absorbs liquid droplets

MIDDLE LAYER

Material properties: Made from synthetic non-woven material that prevents water absorption

Material examples: Polypropylene or cotton layers

Function: Increase the filtration or absorbs liquid droplets

OUTER LAYER

Material properties: Hydrophobic (repels water)

Material examples: Polypropylene, polyester or a mix of both

Function:

Limits external contamination from penetrating through to the wearer's nose and mouth

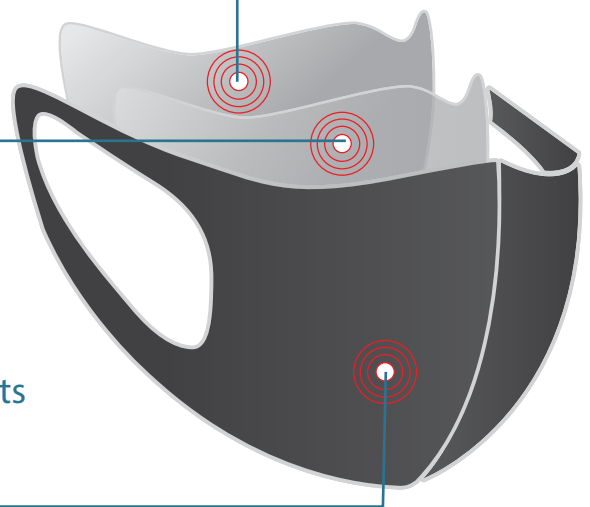

Source: Ministry of Health and WHO

STANDARD PROTECTIVE MASK

PROFESSIONAL TEST REPORTS

SGS and Intertek Certified

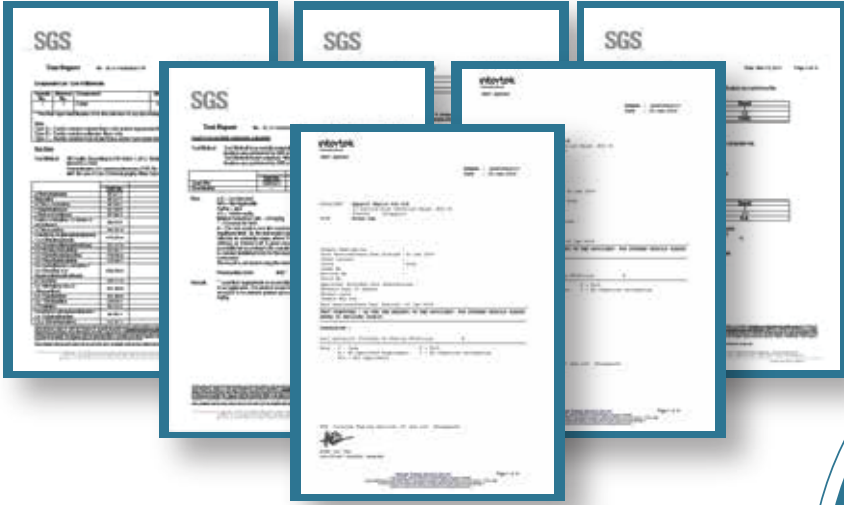

OUTERMOST LAYER

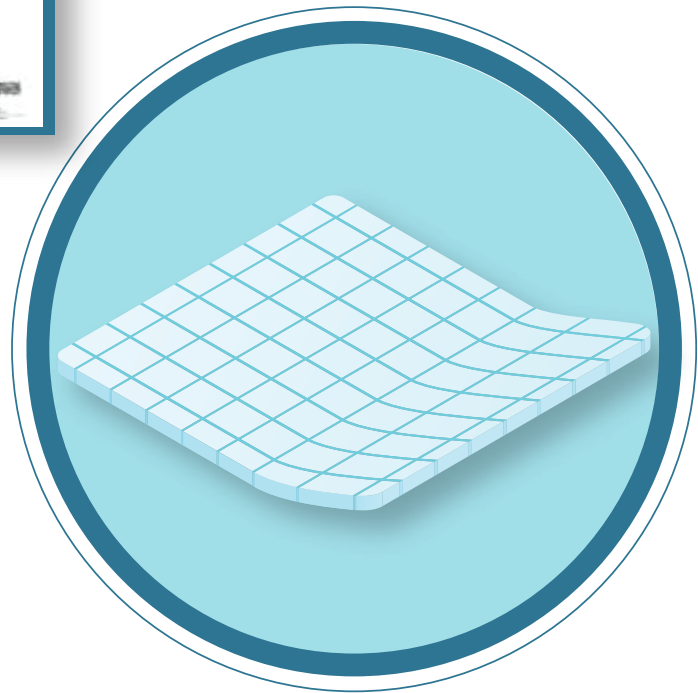

Eliminating 99.4% of Bacteria with Ultifresh™ Technology

CENTER LAYER



BFE 99%

Official Recognition of The Medical Standard



Melt-blown fabric to filter contaminants

99% Bacterial Filtration Efficiency

DUST FREE BACTERIA FREE CLOSURE ROOM



AVAILABLE DESIGNS

Adult Mask



RM01
Onyx Black



RM02
Orange



RM03
Mid-Night Grey



RM04
Iron Grey



RM05
Basil Green



RM06
Unicorna



RM07
US Army Camo

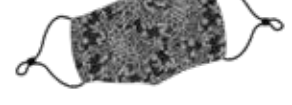

RM08
Lace Print



RM09
US Army
Winter



RM10
US Army
Desert



RM11
Yarn Infuse
(Black)



RM12
Navy Blue



RM13
White

Kids Mask

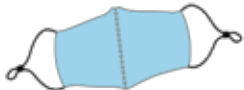

RMK1
Light
Blue



RMK2
Candid
Sheepy



KRM3
Zoofoo



RMK4
Onyx Black



RMK5
Ninablossom



RMK6
Unicorna



RMK7
Dino
& Casa



RMK8
Jungle
Kel



RMK9
Twinkle
Twinkle



RMK10
Light
Grey



RMK11
US Army
Winter



RMK12
White

PRODUCT DISPLAY



CUSTOMER REVIEWS

More than 1000+ positive review

Ratings & Reviews of 🧤** [READY⚡STOCK] (Ultifresh Reusable🔄WashableMask) [1 Reusable Mask + 1 Virus Filter Sheet ...

4.8/5



729 Ratings



Product Reviews

Sort: Relevance

Filter: All star



by Sharif-Sharmizi S. Verified Purchase

3 weeks ago

Item arrived very quickly, I am pleased with the material and how easy it is to fit the filter into the mask. Because it is also not made out of a hard material, it means it is easier to breathe in and comfortable to wear. Recommended.



Color Family:1 Navy Blue Color Reusable Mask + 1 Virus Filter Sheet



"Yes, happy with the quality and pretty comfy. It fits well too!"
- **Elson, Nicole & Christy in the Steel Industries (JB)**



"Have my son to wear the mask as it offers maximum protection & fits his face contour with its construction."
- **Shermaine (SG) Researcher**



"The mask is awesome! 🥰 Dimensional cut design & high quality breathable material with additional adjustable slot for the filter. It's really comfortable. I can breathe well, love it so much! ❤️❤️ This mask is worth it. Definitely recommend this product. 👍" - **Beyonic**

CUSTOMIZE DESIGNS

Past Projects

Customize Label

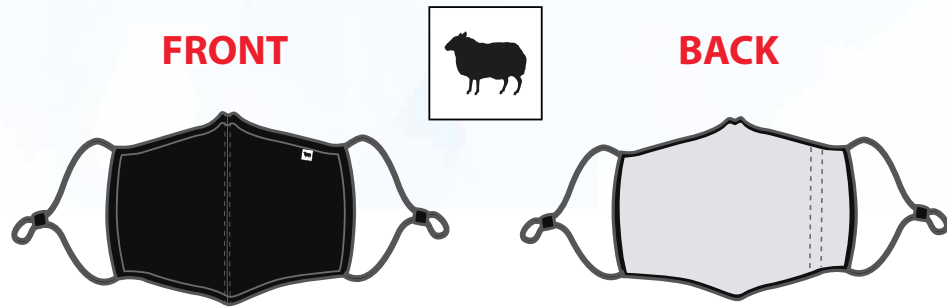

VIDEOJET.

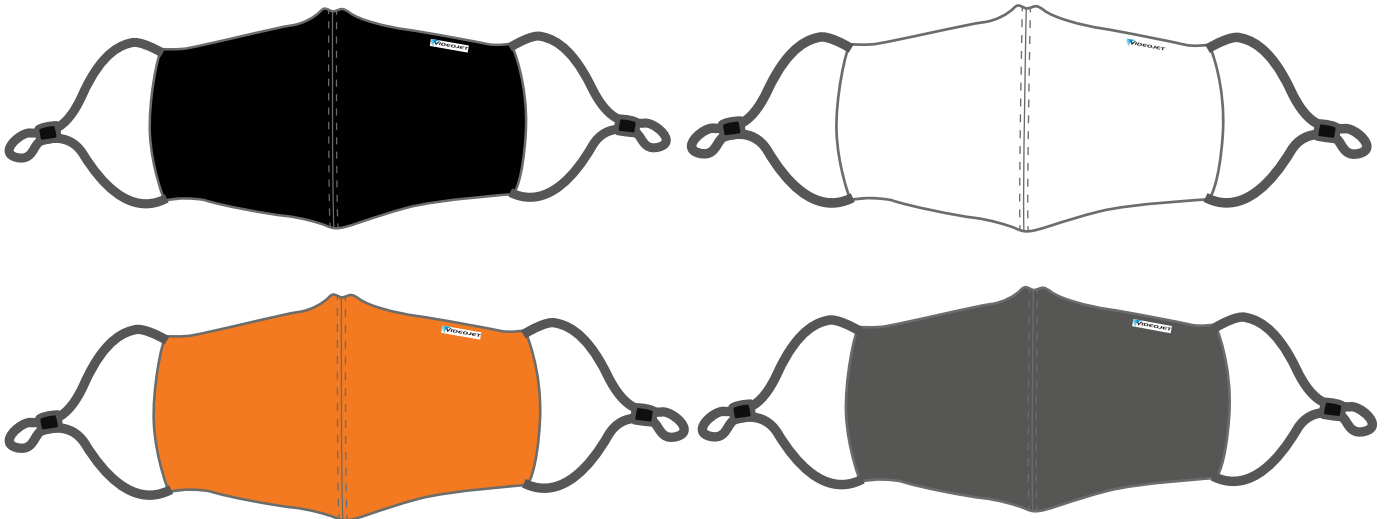

CUSTOMIZE DESIGNS

Past Projects

Full Dye Sub

FRONT



BACK

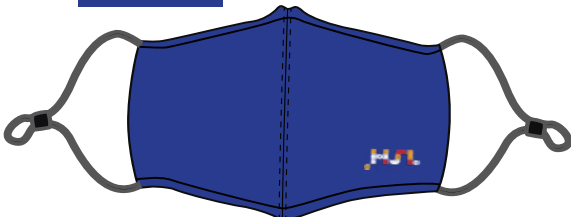
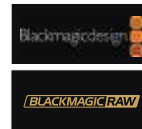
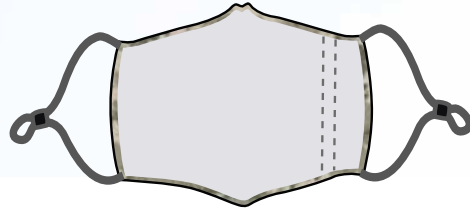

CUSTOMIZE DESIGNS

Past Projects

Custom Print/Embroidery

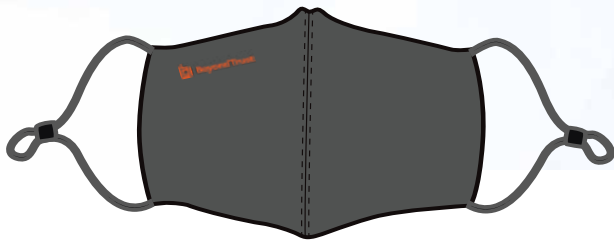

G-SHOCK



gpis

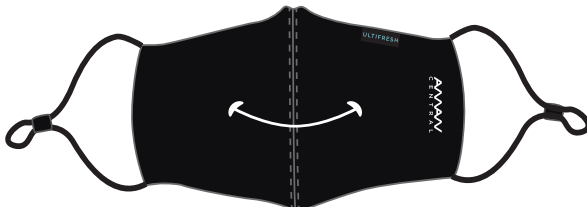

THE ONE ENGLISH ACADEMY

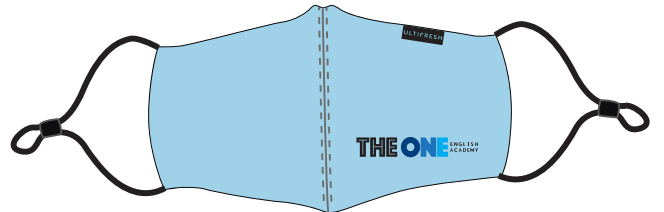

JRM



ZooNessara



CUSTOM MADE

Open For Printing of Own Logo / Design

CHOOSE
YOUR
MASK
COLOR



YOUR
DESIRED
LOGO/
DESIGN

POSITIONING
OF OWN LOGO
OR DESIGN
AT MASK EDGE, LEFT CORNER



MASK
ACCESSORIES
CUSTOMIZATION
(LABEL, STRAPS, SIZE)



WHERE TO BUY



SINGAPORE

READY STOCK AVAILABLE AT THE FOLLOWING STORES

guardian



Lazada mothercare

Pacific Bookstores
Your Partner in Education

MALAYSIA

READY STOCK AVAILABLE AT THE FOLLOWING PHARMACIES

- Alex Pharmacy
- Ascen Plus Pharmacy
- Avanti Pharmacy
- Big Pharmacy
- Careplus Pharmacy
- Caring Pharmacy
- Farmasi Howe Cheang Medical Supply
- Farmasi Murni Marketing
- Farmasi Sungai Pelek Healthcare Enterprise

- First Pharmacy
- Georgetown Pharmacy Langkawi
- Georgetown Medical Supplies
- Gold Coast Pharmacy
- Gold River Pharmacy
- Green Trees Pharmacy
- Happy Pharmacy
- Healthway Pharmacy
- HTM Pharmacy

- IJ Pharmacy
- Mediland Pharmacy
- Mega Kulim Pharmacy
- MY Pharmacy
- Pharmacy Alley
- Pharmhouse Farmasi
- Pure Pharmacy
- SK Pharmacy
- TMC Pharmacy
- Wah Choi Pharmacy
- Wellings Pharmacy

ORDER FORM



Singapore Head Office

Address : 23 Genting Road, #03-03, Chevalier House, Singapore 349481

Operation Hours : Monday - Friday | 09:00a.m. to 06:00p.m. (Local Time)

Phone No. : +65 6282 2858 | Fax : +65 6282 2856

Malaysia Branch Office

Address : No.15 Jalan Desa Tropika 1, Taman Perindustrian Tropika, 81800 Ulu Tiram, Johor, Malaysia

Operation Hours : Monday - Friday | 08:30a.m. to 05:30p.m. (Local Time)

Phone No. : +607 213 2078 | +6011 3178 1707

赣州优迪飞服饰有限公司

Address : 中国江西省赣州市于都县楂林工业园龙门路北侧，
怡信大道东侧（怡信路57号4楼无尘车间）